

**M12-Round-Plug Connector, Single-Ended Cordsets,
According to IEC 61076-2-101**

RKTS | RKWTH



4-, 5-, and 8-Poles (Shielded)

Actuator/sensor cordset, single-ended, M12, 4-, 5-, and 8-poles, female straight connector, internal threads with threaded joint and molded cable, shielding connecting to knurled nut.

RKTS

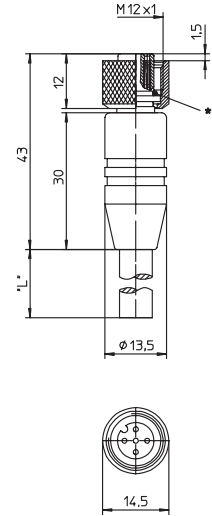

Actuator/sensor cordset, single-ended, M12, 4-, 5-, and 8-poles, female 90 °connector, internal threads with threaded joint and molded cable, shielding connecting to knurled nut.

RKWTH

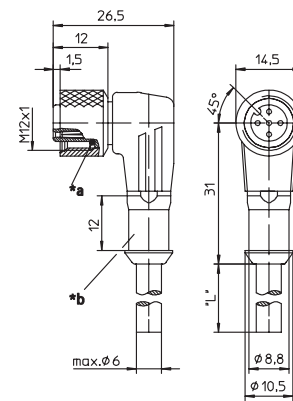

Pin Assignments

M12 - Female

4 poles

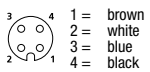

5 poles

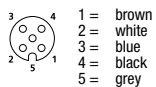

8 poles

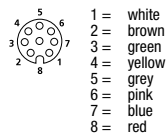



M12-Round-Plug Connector, Single-Ended Cordsets, According to IEC 61076-2-101 RKTS | RKWTH

Technical Data

Environmental

Degree of protection IP 67 / NEMA 6P
Operating temperature range -25°C (-13°F) / +80°C (+176°F)

Mechanical

Housing / Molded body TPU
Insert TPU
Contact CuSn, pre-nickel and 0.8 microns gold-plated
Coupling nut CuZn, nickel-plated
Shield sleeve CuZn, nickel-plated
O-ring FKM

Electrical









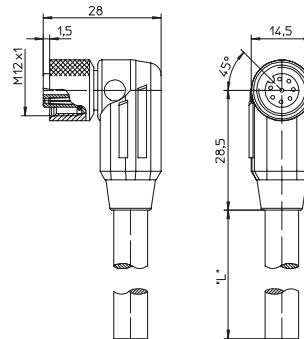





Contact resistance ≤ 5 mΩ
Nominal current at 40°C 4 A
Nominal voltage 4 poles 240 V
5 poles 60 V
8 poles 30 V
Rated voltage 3-4 poles 250 V
5 poles 63 V
8 poles 36 V
Test voltage 3-4 poles 2.0 kV eff. / 60 s
5-8 poles 1.5 kV eff. / 60 s
Insulation resistance > 10⁹ Ω

Cable Specifications

Cable No.	Outer Jacket	Conductor Size	Jacket Color	OD
182	PVC, shielded	4 x 0.34 mm ²	Orange	.217" (5.5 mm)
183	PVC, shielded	5 x 0.34 mm ²	Orange	.236" (6.0 mm)
184	PVC, shielded	8 x 0.25 mm ²	Orange	.260" (6.6 mm)
288	PUR, halogen-free, shielded	4 x 0.34 mm ²	Black	.217" (5.5 mm)
298	PUR, halogen-free, shielded	5 x 0.34 mm ²	Black	.236" (6.0 mm)
299	PUR, halogen-free, shielded	8 x 0.25 mm ²	Black	.260" (6.6 mm)

RKWTH (8-pole version)



Part Number	Part Number	Pins	Outer Jacket	Standard Cable Lengths	Characteristics
Female Straight	Female 90°				
RKTS 4-182/...M	RKWTH 4-182/...M	4	PVC	2 M / 5 M / 10 M	
RKTS 4-288/...M	RKWTH 4-288/...M		PUR, halogen-free	2 M / 5 M / 10 M	   
RKTS 5-183/...M		5	PVC	2 M / 5 M / 10 M	
RKTS 5-298/...M	RKWTH 5-298/...M		PUR, halogen-free	2 M / 5 M / 10 M	   
RKTS 8-184/...M		8	PVC	2 M / 5 M / 10 M	
RKTS 8-299/...M	RKWTH 8-299/...M		PUR, halogen-free	2 M / 5 M / 10 M	   

Mouser Electronics

Authorized Distributor

Click to View Pricing, Inventory, Delivery & Lifecycle Information:

Lumberg Automation:

[RKTS 8-299/10 M](#) [RKTS 8-299/15 M](#) [RKTS 8-299/2 M](#) [RKTS 8-299/20 M](#) [RKTS 8-299/5 M](#) [RKTS 8-184/5 M](#) [RKTS 5-183/2 M](#) [RKTS 5-183/5 M](#) [RKTS 5-298/10 M](#) [RKTS 5-298/2 M](#) [RKTS 5-298/30 M](#) [RKTS 5-298/5 M](#) [RKTS 4-288/10 M](#) [RKTS 4-288/15 M](#) [RKTS 4-288/2 M](#) [RKTS 4-288/20 M](#) [RKTS 4-288/5 M](#) [RKTS 5-183/10 M](#) [RKTS 8-184/15 M](#) [RKTS 8-184/2 M](#) [RKTS 8-299/3 M](#) [RKTS 8-299/30 M](#) [RKTS 8-299/40 M](#) [RKTS 4-182/5 M](#) [RKTS 4-182/10 M](#) [RKTS 4-182/15 M](#) [RKTS 4-288/35 M](#) [RKTS 5-298/15 M](#) [RKTS 5-298/20 M](#) [RKTS 8-184/10 M](#)